

KINTEK®

MODULAR BORING SYSTEM
SISTEMA MODULARE DI BARENATURA



www.kintek.it

**MODULAR
BORING SYSTEM** 

SISTEMA MODULARE
DI BARENATURA 

MODULAR
BOHRSYSTEM 

SISTEMA MODULAR
DE ESCARIADO 

SYSTÈME MODULAIRE
D'ALÉSAGE 

МОДУЛЬНАЯ СИСТЕМА
ДЛЯ РАСТОЧНЫХ РЕЗЦОВ 

钻镗系统 

BORING SYSTEM

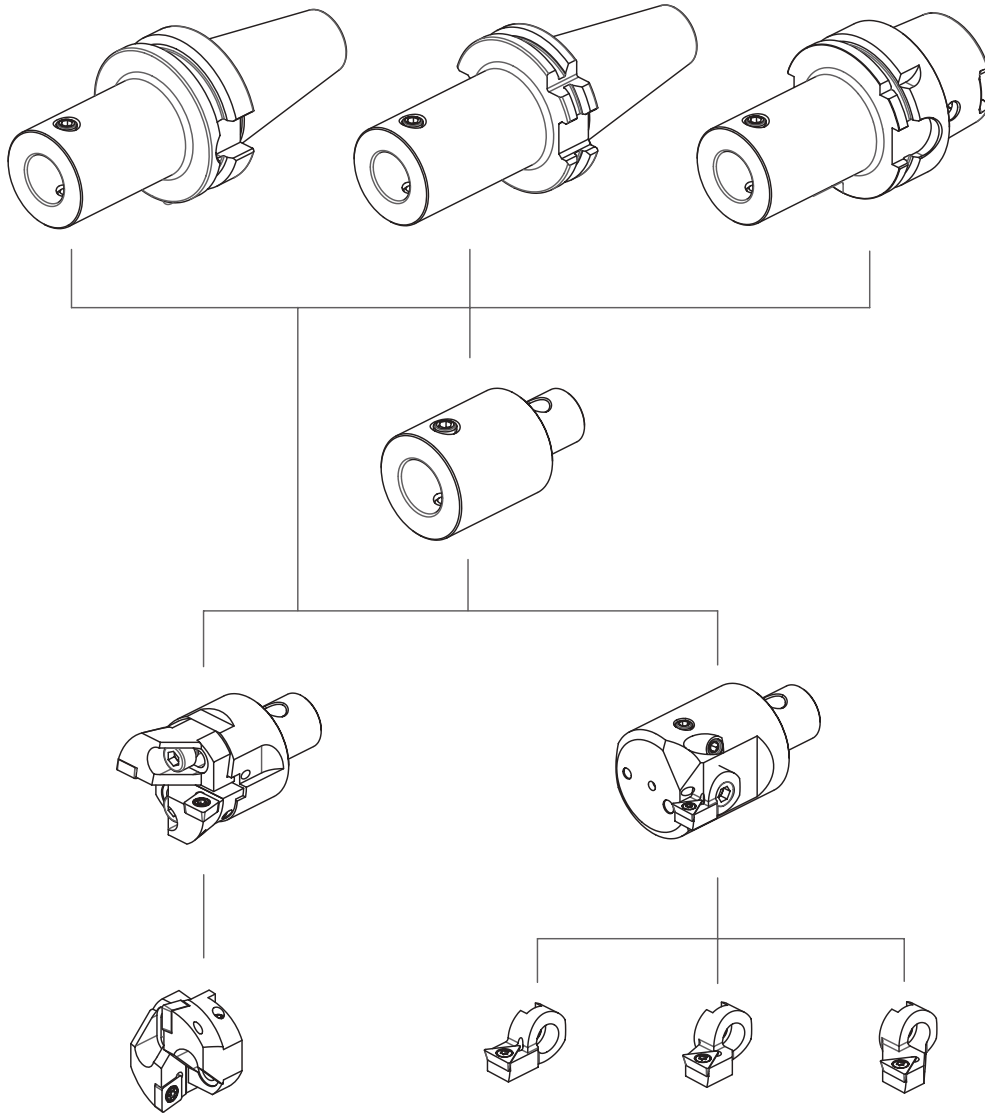

01

KINTEK®

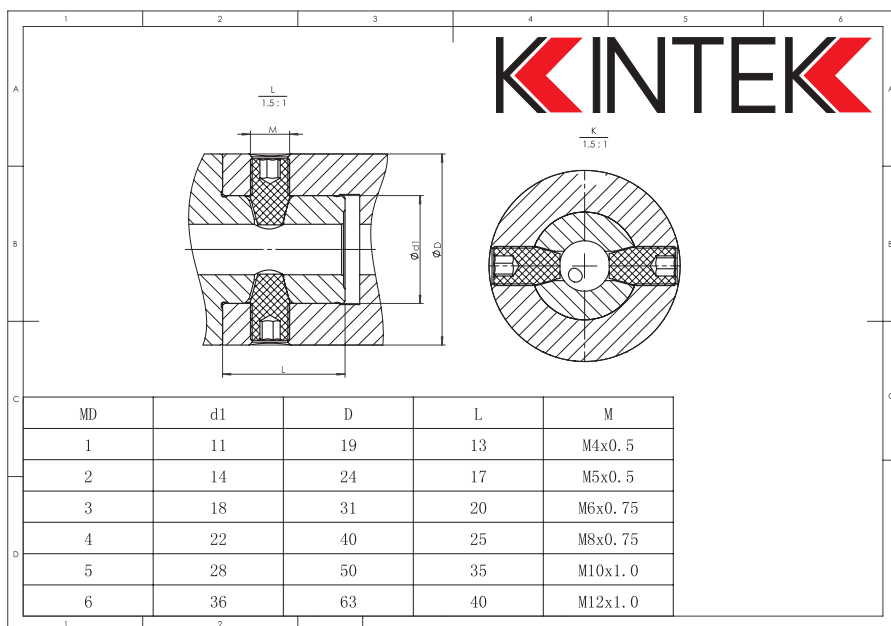

POLYAGONAL ARBORS FOR BORING HEADS

GRUNDAUFNAHME FÜR BOHRKÖPFE MIT POLYGONSCHAFT ATTACCO BASE PER TESTINE DI ALESATURA – POLIGONALE
 PORTAS PARA CABEZALES DE MANDRINAR - MANGO POLYGONAL MANDRINS POUR TÊTE D'ALESAGE AVEC ATTACHMENT POLYGONALE
 ОПРАВКИ ДЛЯ ПОЛИГОНАЛЬНЫХ ГОЛОВОК 多边形接口的镗头座

DIN ISO 26623-1

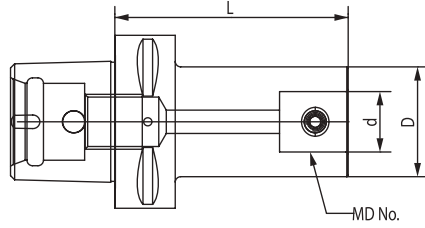

CODE N.	DESCRIPTION	POLIGONAL	MD No.	D	L	d	CONNECTION SCREW	Qt.
290-07601	C50H85MD2	50	2	24	85	14	811-402093	2
290-07602	C50H100MD2	50	2	24	100	14	811-402093	2
290-07603	C50H95MD3	50	3	31	95	18	811-402094	2
290-07604	C50H125MD3	50	3	31	125	18	811-402094	2
290-07605	C50H85MD4	50	4	40	85	22	811-402095	2
290-07606	C50H130MD4	50	4	40	130	22	811-402095	2
290-07607	C50H75MD5	50	5	50	75	28	811-402096	2
290-07608	C50H125MD5	50	5	50	125	28	811-402096	2
290-07609	C63H85MD2	63	2	24	85	14	811-402093	2
290-07610	C63H100MD2	63	2	24	100	14	811-402093	2
290-07611	C63H95MD3	63	3	31	95	18	811-402094	2
290-07612	C63H125MD3	63	3	31	125	18	811-402094	2
290-07613	C63H85MD4	63	4	40	85	22	811-402095	2
290-07614	C63H130MD4	63	4	40	130	22	811-402095	2
290-07615	C63H75MD5	63	5	50	75	28	811-402096	2
290-07616	C63H125MD5	63	5	50	125	28	811-402096	2

ARBORS FOR BORING HEADS –MAS403/BT-AD

GRUNDAUFNAHMEN FUER BOHRKÖPFE – MAS403/BT-AD ATTACCO BASE PER TESTINE DI ALESATURA - MAS403/BT-AD
 PORTAS PARA CABEZALES DE MANDRINAR – MAS403/BT-AD MANDRINS POUR TETES D'ALESAGE- MAS403/BT-AD
 ОПРАВКИ ДЛЯ РАСТОЧНЫХ ГОЛОВОК – MAS403/BT-AD 镗头接头座-符合标准 MAS403/BT-AD

JIS-B 6339 MAS 403/BT

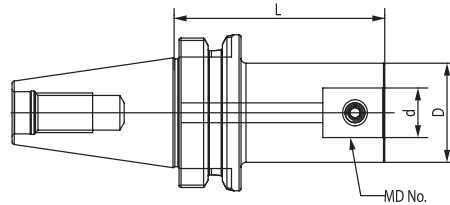

CODE N.	DESCRIPTION	BT	MD No.	D	L	d	CONNECTION SCREW	Qt.
290-01517	BT30H80MD2	30	2	24	80	14	811-402093	2
290-01518	BT30H80MD3	30	3	31	80	18	811-402094	2
290-01519	BT30H70MD4	30	4	40	70	22	811-402095	2
290-01520	BT30H60MD5	30	5	50	60	28	811-402096	2
290-01501	BT40H85MD2	40	2	24	85	14	811-402093	2
290-01502	BT40H100MD2	40	2	24	100	14	811-402093	2
290-01503	BT40H95MD3	40	3	31	95	18	811-402094	2
290-01504	BT40H125MD3	40	3	31	125	18	811-402094	2
290-01505	BT40H85MD4	40	4	40	85	22	811-402095	2
290-01506	BT40H130MD4	40	4	40	130	22	811-402095	2
290-01507	BT40H75MD5	40	5	50	75	28	811-402096	2
290-01508	BT40H125MD5	40	5	50	125	28	811-402096	2
290-01521	BT40H65MD6	40	6	64	65	36	811-402101	2
290-01522	BT40H115MD6	40	6	64	115	36	811-402101	2
290-01509	BT50H85MD2	50	2	24	85	14	811-402093	2
290-01510	BT50H110MD2	50	2	24	110	14	811-402093	2
290-01511	BT50H80MD3	50	3	31	80	18	811-402094	2
290-01512	BT50H125MD3	50	3	31	125	18	811-402094	2
290-01513	BT50H115MD4	50	4	40	115	22	811-402095	2
290-01514	BT50H145MD4	50	4	40	145	22	811-402095	2
290-01515	BT50H105MD5	50	5	50	105	28	811-402096	2
290-01516	BT50H180MD5	50	5	50	180	28	811-402096	2
290-01523	BT50H95MD6	50	6	64	95	36	811-402101	2
290-01524	BT50H170MD6	50	6	64	170	36	811-402101	2

ARBORS FOR BORING HEADS – DIN69871-AD

GRUNDAUFNAHMEN FUER BOHRKÖPFE – DIN69871-AD ATTACCO BASE PER TESTINE DI ALESATURA - DIN69871-AD
 PORTAS PARA CABEZALES DE MANDRINAR – DIN69871-AD MANDRINS POUR TETES D’ALESAGE- DIN69871-AD
 ОПРАВКИ ДЛЯ РАСТОЧНЫХ ГОЛОВОК – DIN69871-AD 镗头接头座 – 符合标准 DIN69871-AD

DIN 69871

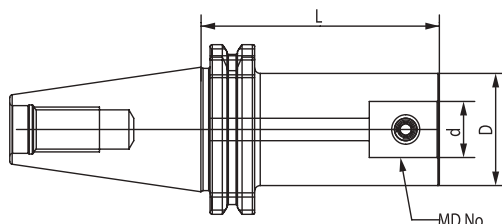

CODE N.	DESCRIPTION	TC	MD No.	D	L	d	CONNECTION SCREW	Qt.
290-01201	TC40H85MD2	40	2	24	85	14	811-402093	2
290-01202	TC40H100MD2	40	2	24	100	14	811-402093	2
290-01203	TC40H95MD3	40	3	31	95	18	811-402094	2
290-01204	TC40H125MD3	40	3	31	125	18	811-402094	2
290-01205	TC40H85MD4	40	4	40	85	22	811-402095	2
290-01206	TC40H130MD4	40	4	40	130	22	811-402095	2
290-01207	TC40H75MD5	40	5	50	75	28	811-402096	2
290-01208	TC40H125MD5	40	5	50	125	28	811-402096	2
290-01217	TC40H65MD6	40	6	64	65	36	811-402101	2
290-01218	TC40H115MD6	40	6	64	115	36	811-402101	2
290-01209	TC50H85MD2	50	2	24	85	14	811-402093	2
290-01210	TC50H110MD2	50	2	24	110	14	811-402093	2
290-01211	TC50H80MD3	50	3	31	80	18	811-402094	2
290-01212	TC50H125MD3	50	3	31	125	18	811-402094	2
290-01213	TC50H115MD4	50	4	40	115	22	811-402095	2
290-01214	TC50H145MD4	50	4	40	145	22	811-402095	2
290-01215	TC50H105MD5	50	5	50	105	28	811-402096	2
290-01216	TC50H180MD5	50	5	50	180	28	811-402096	2
290-01219	TC50H95MD6	50	6	64	95	36	811-402101	2
290-01220	TC50H170MD6	50	6	64	170	36	811-402101	2

ARBORS FOR BORING HEADS – DIN69893/4

GRUNDAUFNAHMEN FUER BOHRKÖPFE – DIN69893/A ATTACCO BASE PER TESTINE DI ALESATURA - DIN69893/A
 PORTAS PARA CABEZALES DE MANDRINAR – DIN69893/A MANDRINS POUR TETES D’ALESAGE- DIN69893/A
 ОПРАВКИ ДЛЯ РАСТОЧНЫХ ГОЛОВОК – DIN69893/4 镗头接头座 – 符合标准 DIN69893/A

DIN 69893/A

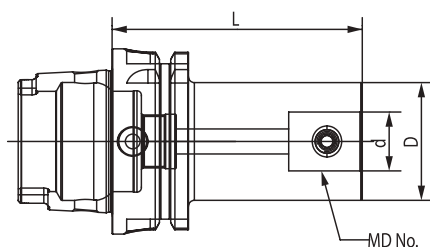

CODE N.	DESCRIPTION	HSK	MD No.	D	L	d	CONNECTION SCREW	Qt.
290-01701	HSK63AH85MD2	63	2	24	85	14	811-402093	2
290-01702	HSK63AH100MD2	63	2	24	100	14	811-402093	2
290-01703	HSK63AH95MD3	63	3	31	95	18	811-402094	2
290-01704	HSK63AH125MD3	63	3	31	125	18	811-402094	2
290-01705	HSK63AH85MD4	63	4	40	85	22	811-402095	2
290-01706	HSK63AH130MD4	63	4	40	130	22	811-402095	2
290-01707	HSK63AH75MD5	63	5	50	75	28	811-402096	2
290-01708	HSK63AH125MD5	63	5	50	125	28	811-402096	2

REDUCTIONS FOR BORING HEADS

REDUKTIONEN FÜR BOHRKÖPFE RIDUZIONI PER TESTINE DI ALESATURA
 REDUCCIONES PARA PORTAS CON CABEZALES DE MANDRINAR RÉDUCTIONS POUR TÊTES D'ALÉSAGE
 ПЕРЕХОДНИКИ ДЛЯ РАСТОЧНЫХ ГОЛОВOK 缩径杆

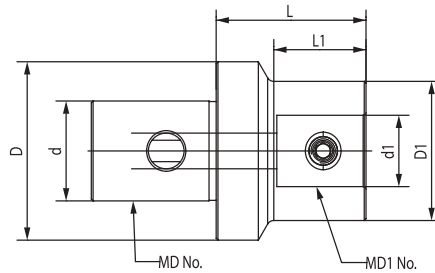

CODE N.	DESCRIPTION	MD No.	MD1 No.	D	D1	L	L1	d	d1	CONNECTION SCREW	Qt.
291-30003	MD3L37MD2	3	2	31	24	37	25	18	14	811-402093	2
291-30005	MD4L50MD2	4	2	40	24	50	36	22	14	811-402093	2
291-30006	MD4L50MD3	4	3	40	31	50	37	22	18	811-402094	2
291-30008	MD5L54MD2	5	2	50	24	54	35	28	14	811-402093	2
291-30009	MD5L47MD3	5	3	50	31	47	29	28	18	811-402094	2
291-30010	MD5L42MD4	5	4	50	40	42	25	28	22	811-402095	2
291-30011	MD6L63MD2	6	2	64	24	63	45	36	14	811-402101	2
291-30012	MD6L56MD3	6	3	64	31	56	39	36	18	811-402101	2
291-30013	MD6L51MD4	6	4	64	40	51	35	36	22	811-402101	2
291-30014	MD6L41MD5	6	5	64	50	41	25	36	28	811-402101	2

EXTENSIONS FOR BORING HEADS

VERLÄNGERUNGEN FÜR BOHRKÖPFE PROLUNGHE PER TESTINE DI ALESATURA
 EXTENSIONES PARA PORTAS CON CABEZALES DE MANDRINAR RALLONGES POUR TÊTES D'ALÉSAGE
 УДЛИНИТЕЛИ ДЛЯ РАСТОЧНЫХ ГОЛОВOK 扩展镗头

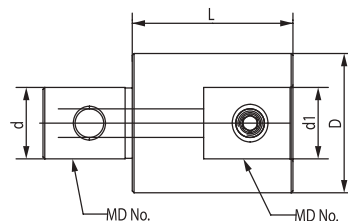

CODE N.	DESCRIPTION	MD No.	D	L	d	d1	CONNECTION SCREW	Qt.
291-20001	MD2L30MD2	2	24	30	14	14	811-402093	2
291-20002	MD3L30MD3	3	31	30	18	18	811-402094	2
291-20003	MD4L45MD4	4	39	45	22	22	811-402095	2
291-20004	MD5L60MD5	5	50	60	28	28	811-402096	2
291-20005	MD6L60MD6	6	64	60	36	36	811-402101	2

DOUBLE-BIT HEADS WITH CARTRIDGE

ZWEISCHNEIDERBOHRKÖPFE MIT EINBAUHALTER
 CABEZAL DE DESBASTE CON DOBLE FILO DE CARTUCHOS
 ДВУХРЕЗЦОВЫЕ ГОЛОВКИ С КАРТРИДЖАМИ

TESTINA DI ALESATURA BILAMA COMPLETA DI CARTUCCE
 TÊTE A DOUBLE TRANCHANT AVEC CARTOUCHE
 带刀片座的双位刀头

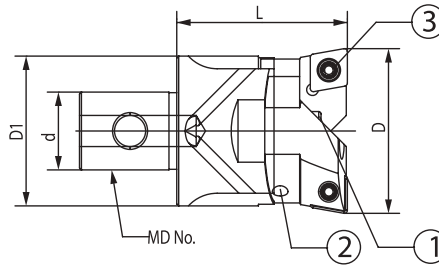

CODE N.	DESCRIPTION	MD No.	D	D1	L	d
523-90001	MD2-CL2533	2	25-33	23,5	35,5	14
523-90002	MD3-CL3242	3	32-42	30,5	40	18
523-90003	MD4-CL4154	4	41-54	38,5	47	22
523-90004	MD5-CL5370	5	53-70	49,5	57	28
523-90005	MD6-CL6890	6	68-90	63	71	36
523-90006	MD6-CL88110	6	88-110	63	71	36
523-90007	MD6-CL98126	6	98-126	63	71	36
523-90008	MD6-CL125153	6	125-153	63	71	36

CODE N.	① LOCK SCREW	① CODE N.	② Qt.	② ADJUSTING SCREW	② CODE N.	① Qt.	① INTERNAL HEX. WRENCH	① CODE N.	② Qt.	② INTERNAL HEX. WRENCH	② CODE N.	② Qt.
523-90001	M5*20	811-401160	2	M3*6	811-402090	2	S4	816-111029	1	S1.5	816-111030	1
523-90002	M6*20	811-401161	2	M4*8	811-402091	2	S5	816-111031	1	S2	816-111032	1
523-90003	M8*25	811-401162	2	M5*8	811-402092	2	S6	816-111028	1	S2.5	816-111034	1
523-90004	M10*35	811-401167	2	M6*12	811-402082	2	S8	816-111020	1	S3	816-111021	1

③ INSERT WRENCH	③ CODE N.	③ Qt.	③ INSERT SCREW	③ CODE N.	③ Qt.	③ CODE N.	③ DESCRIPTION	③ MD N	③ MD NO	③ INSERT	③ CODE N.	③ INSERT SCREW	③ Qt.
T8	816-122010	1	m2,5x6	811-226018	2	523-90001	CRT-2533	2	2	CC..0602..	811-226018	M2.5*6	2
T15	816-122011	1	m4x10	811-256026	2	523-90002	CRT-3242	3	2	CC..09T3..	811-256026	M4*10	2
T15	816-122011	1	m4x10	811-256026	2	523-90003	CRT-4154	4	2	CC..09T3..	811-256026	M4*10	2
T20	816-122012	1	m5x12	811-256027	2	523-90004	CRT-5370	5	2	CC..1204..	811-256027	M5*12	2

* COMPLETA DI CARTUCCIA - * CARTRIDGE INCLUDED

COUPLE OF SPARE CARTRIDGES FOR TWIN CUTTER BORING HEADS

EINBAUHALTERPAAR FÜR ZWEISCHNEIDERBOHRKOPF
 PAR DE CARTUCHOS DE RECAMBIO
 PARA CABEZALES DE DESBASTE DOBLE FILO
 СМЕННЫЕ КАРТРИДЖИ ДЛЯ ДВУХРЕЗЦОВЫХ ГОЛОВОК

COPPIA DI CARTUCCE DI RICAMBIO PER TESTINE DI ALESATURA BILAMA
 COUPLE DE CARTOUCHES POUR TÊTE D'ALÉSAGE À LAME DOUBLE TRANCHANT
 双位刀头的刀片座配件(一对)

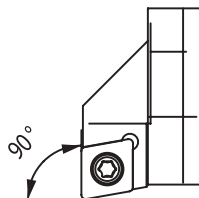

CODE N.	DESCRIPTION	MD No.	INSERT	INSERT SCREW	Qt.
524-90001	CRT-2533	2	CC..0602..	811-226018	2
524-90002	CRT-3242	3	CC..09T3..	811-256026	2
524-90003	CRT-4154	4	CC..09T3..	811-256026	2
524-90004	CRT-5370	5	CC..1204..	811-256027	2
524-90005	CRT-6890	6	CC..1204..	811-256027	2
524-90006	CRT-88110	6	CC..1204..	811-256027	2
524-90007	CRT-98126	6	CC..1204..	811-256027	2
524-90008	CRT-125153	6	CC..1204..	811-256027	2

FINISHING BORING HEADS WITH CARTRIDGE (*)

FEINBEARBEITUNGSKÖPFE MIT EINBAUHALTER (*) TESTINA DI ALESATURA PER FINITURA COMPLETA DI CARTUCCIA (*)

CABEZAL DE ACABADO CON CARTUCHO (*) TETES D'ALEPAGE DE FINITION AVEC CARTOUCHE (*)

ПРЕЦИЗИОННЫЕ РАСТОЧНЫЕ ГОЛОВКИ С КАРТРИДЖАМИ (*) 带刀片座的精镗头 (*)

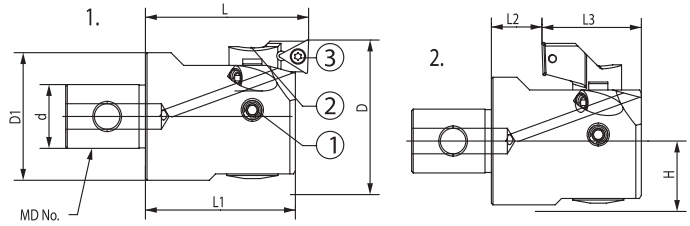

CODE N.	DESCRIPTION	MD No.	d	CARTRIDGE	1.				2.			
					D	D1	L	L1	D	L2	L3	H
533-90001	MD2-FNT2547	2	14	*534-90001	25-33				-			
				534-90002	32-40	24	35,5	33	36-40	11,5	21,5	12,5
				534-90003	39-47				39-47			
533-90002	MD3-FNT3260	3	18	*534-90004	32-42				-			
				534-90005	41-51	31	40	37	46-51	10	27	16
				534-90006	50-60				50-60			
533-90003	MD4-FNT4174	4	22	*534-90007	41-54				-			
				534-90008	50-63	40	47	43	53-63	12	31	20
				534-90009	61-74				61-74			
533-90004	MD5-FNT5395	5	28	*534-90010	53-70				-			
				534-90011	65-82	50	57	52	65-82	15	37	25,5
				534-90012	78-95				78-95			
533-90005	MD6-FNT68150	6	36	*534-90013	68-100				-			
				534-90014	94-126	64	71	67	94-126	23	44	32,5
				534-90015	118-150				118-150			

CODE N.	① LOCK SCREW	① CODE N.	① QT.	② LOCK SCREW FOR CARTRIDGE	② CODE N.	② QT.	①-② ADJUSTING WRENCH	①-② CODE N.	①-② QT.	③ INSERT WRENCH	③ CODE N.	③ QT.	③ INSERT SCREW	③ CODE N.	③ QT.
533-90001	M4*5	811-401163	1	M3*6	811-402086	1	S2	816-111035	1	T6	816-122009	1	M2*4,5	811-286007	1
533-90002	M5*6	811-401164	1	M4*8	811-402087	1	S2,5	816-111036	1	T6	816-122009	1	M2*5	811-286008	1
533-90003	M6*10	811-401165	1	M5*10-S3	811-402088	1	S3	816-111037	1	T8	816-122010	1	M2,5*6	811-226018	1
533-90004	M8*12	811-401166	1	M5*10-S4	811-402089	1	S4	816-111038	1	T8	816-122010	1	M2,5*6	811-226018	1
533-90005	M10*16	811-401168	1	M8*12-S5	811-402097	1	S5	816-111031	1	T8	816-122010	1	M2,5*6	811-226018	1

* CARTRIDGE ASSEMBLED IN BORING HEAD
 * CARTUCCIA MONTATA NELLA TESTINA
 * EINBAULTER MONTIERT AUF DEM KOPF

(*) CARTUCHO MONTADO EN EL CABEZAL
 * CARTOUCHE MONTÉE DANS LA TÊTE
 * КАРТРИДЖИ УСТАНОВЛЕННЫ НА

РАСТОЧНУЮ ГОЛОВКУ
 * 安装在刀头的刀片座

CARTRIDGES FOR FINISHING BORING HEADS

EINBAUHALTER FÜR FEINBEARBEITUNGSKÖPFE

CARTUCCE PER TESTINE DI ALESATURA DI FINITURA

CARTUCHOS PARA CABEZALES DE ACABADO

CARTOUCHES POUR TETES D'ALEPAGE DE FINITION

КАРТРИДЖИ ДЛЯ ПРЕЦИЗИОННЫХ РАСТОЧНЫХ ГОЛОВОК

精镗头的刀片座

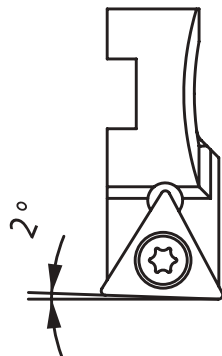

CODE N.	DESCRIPTION	MD No.	INSERT	INSERT SCREW	Qt.
534-90001	CRF-2533/MD2	2	TC..06T102..	811-286007	1
534-90002	CRF-3240/MD2				
534-90003	CRF-3947/MD2				
534-90004	CRF-3242/MD3	3			
534-90005	CRF-4151/MD3				
534-90006	CRF-5060/MD3				
534-90016	CRF-2735/MD2	2	CC..0602..	811-226018	1
534-90017	CRF-3240/MD2				
534-90018	CRF-3947/MD2				
534-90019	CRF-3242/MD3	3			
534-90020	CRF-4154/MD3				
534-90021	CRF-5060/MD3				
534-90007	CRF-4154/MD4	4	TC..1102..	811-226018	1
534-90008	CRF-5063/MD4				
534-90009	CRF-6174/MD4				
534-90010	CRF-5370/MD5	5			
534-90011	CRF-6582/MD5				
534-90012	CRF-7895/MD5				
534-90013	CRF-68100/MD6	6	TC..1102..	811-226018	1
534-90014	CRF-94126/MD6				
534-90015	CRF-118150/MD6				

KIT



CODE	TOOLHOLDER		HEAD		CARTRIDGE
KIT533SK40MD2	290-01201	TC40H85MD2	533-90001	FINISHING BORING HEAD MD2-FNT25-47	534-90001 25-33 TC..06T102..
KIT533BT40MD2	290-01501	BT40H85MD2	533-90001	FINISHING BORING HEAD MD2-FNT25-47	534-90001 25-33 TC..06T102..
KIT533SK40MD3	290-01203	TC40H95MD3	533-90002	FINISHING BORING HEAD MD3-FNT32-60	534-90004 32-42 TC..06T102..
KIT533BT40MD3	290-01503	BT40H95MD3	533-90002	FINISHING BORING HEAD MD3-FNT32-60	534-90004 32-42 TC..06T102..
KIT533SK40MD4	290-01205	TC40H85MD4	533-90003	FINISHING BORING HEAD MD4-FNT41-74	534-90007 41-54 TC..1102..
KIT533BT40MD4	290-01505	BT40H85MD4	533-90003	FINISHING BORING HEAD MD4-FNT41-74	534-90007 41-54 TC..1102..
KIT533SK40MD5	290-01207	TC40H75MD5	533-90004	FINISHING BORING HEAD MD5-FNT53-95	534-90010 53-70 TC..1102..
KIT533BT40MD5	290-01507	BT40H75MD5	533-90004	FINISHING BORING HEAD MD5-FNT53-95	534-90010 53-70 TC..1102..
KIT533SK40MD2L	290-01202	TC40H100MD2	533-90001	FINISHING BORING HEAD MD2-FNT25-47	534-90001 25-33 TC..06T102..
KIT533BT40MD2L	290-01502	BT40H100MD2	533-90001	FINISHING BORING HEAD MD2-FNT25-47	534-90001 25-33 TC..06T102..
KIT533SK40MD3L	290-01204	TC40H125MD3	533-90002	FINISHING BORING HEAD MD3-FNT32-60	534-90004 32-42 TC..06T102..
KIT533BT40MD3L	290-01504	BT40H125MD3	533-90002	FINISHING BORING HEAD MD3-FNT32-60	534-90004 32-42 TC..06T102..
KIT533SK40MD4L	290-01206	TC40H130MD4	533-90003	FINISHING BORING HEAD MD4-FNT41-74	534-90007 41-54 TC..1102..
KIT533BT40MD4L	290-01506	BT40H130MD4	533-90003	FINISHING BORING HEAD MD4-FNT41-74	534-90007 41-54 TC..1102..
KIT533SK40MD5L	290-01208	TC40H125MD5	533-90004	FINISHING BORING HEAD MD5-FNT53-95	534-90010 53-70 TC..1102..
KIT533BT40MD5L	290-01508	BT40H125MD5	533-90004	FINISHING BORING HEAD MD5-FNT53-95	534-90010 53-70 TC..1102..
KIT533HSKMD2	290-01701	HSK63AH85MD2	533-90001	FINISHING BORING HEAD MD2-FNT25-47	534-90001 25-33 TC..06T102..
KIT533HSKMD3	290-01703	HSK63AH95MD3	533-90002	FINISHING BORING HEAD MD3-FNT32-60	534-90004 32-42 TC..06T102..
KIT533HSKMD4	290-01705	HSK63AH85MD4	533-90003	FINISHING BORING HEAD MD4-FNT41-74	534-90007 41-54 TC..1102..
KIT533HSKMD5	290-01707	HSK63AH75MD5	533-90004	FINISHING BORING HEAD MD5-FNT53-95	534-90010 53-70 TC..1102..
KIT533HSKMD2L	290-01702	HSK63AH100MD2	533-90001	FINISHING BORING HEAD MD2-FNT25-47	534-90001 25-33 TC..06T102..
KIT533HSKMD3L	290-01704	HSK63AH125MD3	533-90002	FINISHING BORING HEAD MD3-FNT32-60	534-90004 32-42 TC..06T102..
KIT533HSKMD4L	290-01706	HSK63AH130MD4	533-90003	FINISHING BORING HEAD MD4-FNT41-74	534-90007 41-54 TC..1102..
KIT533HSKMD5L	290-01708	HSK63AH125MD5	533-90004	FINISHING BORING HEAD MD5-FNT53-95	534-90010 53-70 TC..1102..
KIT533C50MD2	290-07601	C50H85MD2	533-90001	FINISHING BORING HEAD MD2-FNT25-47	534-90001 25-33 TC..06T102..
KIT533C50MD3	290-07603	C50H95MD3	533-90002	FINISHING BORING HEAD MD3-FNT32-60	534-90004 32-42 TC..06T102..
KIT533C50MD4	290-07605	C50H85MD4	533-90003	FINISHING BORING HEAD MD4-FNT41-74	534-90007 41-54 TC..1102..
KIT533C50MD5	290-07607	C50H75MD5	533-90004	FINISHING BORING HEAD MD5-FNT53-95	534-90010 53-70 TC..1102..
KIT533C50MD2L	290-07602	C50H100MD2	533-90001	FINISHING BORING HEAD MD2-FNT25-47	534-90001 25-33 TC..06T102..
KIT533C50MD3L	290-07604	C50H125MD3	533-90002	FINISHING BORING HEAD MD3-FNT32-60	534-90004 32-42 TC..06T102..
KIT533C50MD4L	290-07606	C50H130MD4	533-90003	FINISHING BORING HEAD MD4-FNT41-74	534-90007 41-54 TC..1102..
KIT533C50MD5L	290-07608	C50H125MD5	533-90004	FINISHING BORING HEAD MD5-FNT53-95	534-90010 53-70 TC..1102..
KIT533C63MD2	290-07609	C63H85MD2	533-90001	FINISHING BORING HEAD MD2-FNT25-47	534-90001 25-33 TC..06T102..
KIT533C63MD3	290-07611	C63H95MD3	533-90002	FINISHING BORING HEAD MD3-FNT32-60	534-90004 32-42 TC..06T102..
KIT533C63MD4	290-07613	C63H85MD4	533-90003	FINISHING BORING HEAD MD4-FNT41-74	534-90007 41-54 TC..1102..
KIT533C63MD5	290-07615	C63H75MD5	533-90004	FINISHING BORING HEAD MD5-FNT53-95	534-90010 53-70 TC..1102..
KIT533C63MD2L	290-07610	C63H100MD2	533-90001	FINISHING BORING HEAD MD2-FNT25-47	534-90001 25-33 TC..06T102..
KIT533C63MD3L	290-07612	C63H125MD3	533-90002	FINISHING BORING HEAD MD3-FNT32-60	534-90004 32-42 TC..06T102..
KIT533C63MD4L	290-07614	C63H130MD4	533-90003	FINISHING BORING HEAD MD4-FNT41-74	534-90007 41-54 TC..1102..
KIT533C63MD5L	290-07616	C63H125MD5	533-90004	FINISHING BORING HEAD MD5-FNT53-95	534-90010 53-70 TC..1102..



MODULAR BORING SYSTEM

01

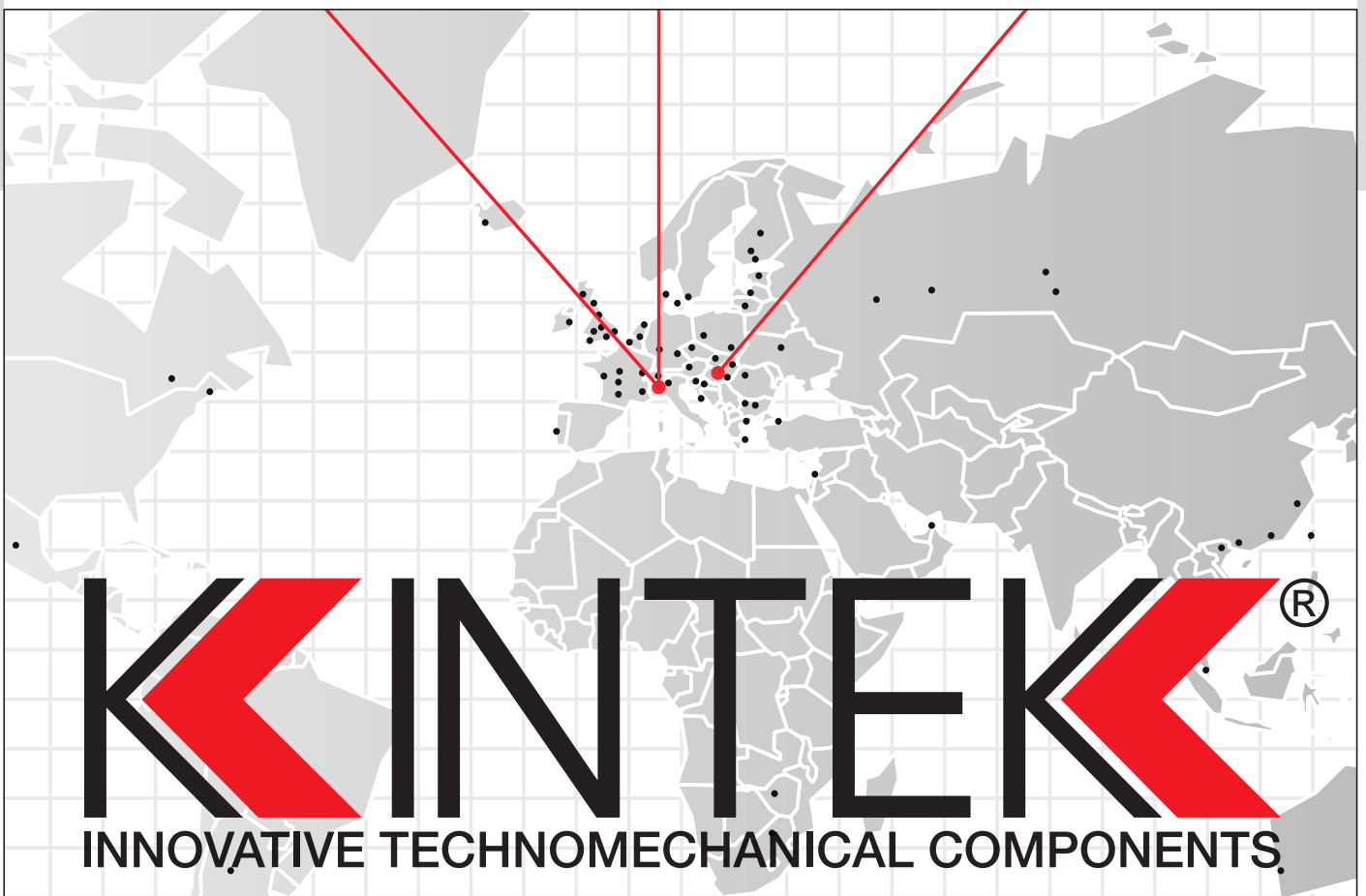

KINTEK®
INNOVATIVE TECHNOMECHANICAL COMPONENTS.